



3N1 Steaming Hot Water Tap

At the pull of a lever, the 3N1 steaming hot water tap can produce steaming hot filtered water, regular hot and regular cold water and replaces your main tap. Ideal for making hot drinks, cleaning, preparing pasta and more.

Features

- The innovative NeoTank features a precise and adjustable thermostat, enabling users to set the desired temperature of the water between 88 and 98°C
- Designed and manufactured in Italy
- Safe, multi step hot water handle
- Elegant one-piece design
- Efficient use of space and time
- Easy to install
- Available in chrome, brushed steel and other finishes
- 5 year tap guarantee and 2 year tank guarantee

PRODUCT SPEC SHEET

3N1
Steaming Hot
Water Tap

Specifications

- Solid, high-quality low lead brass
- Complete installation kit for solid surface mount
- Capacity: 2.5 litre stainless steel tank filtered steaming hot water
- Tap height: 300mm
- Required hole diameter: 35-38mm
- Required supply pressure (cold): 172-862 kPa (1.7-8.6 bar) (25-125 psi)
- Required supply pressure (hot): 50xPa (0.5 bar) (7 psi)

Dimensions (mm)

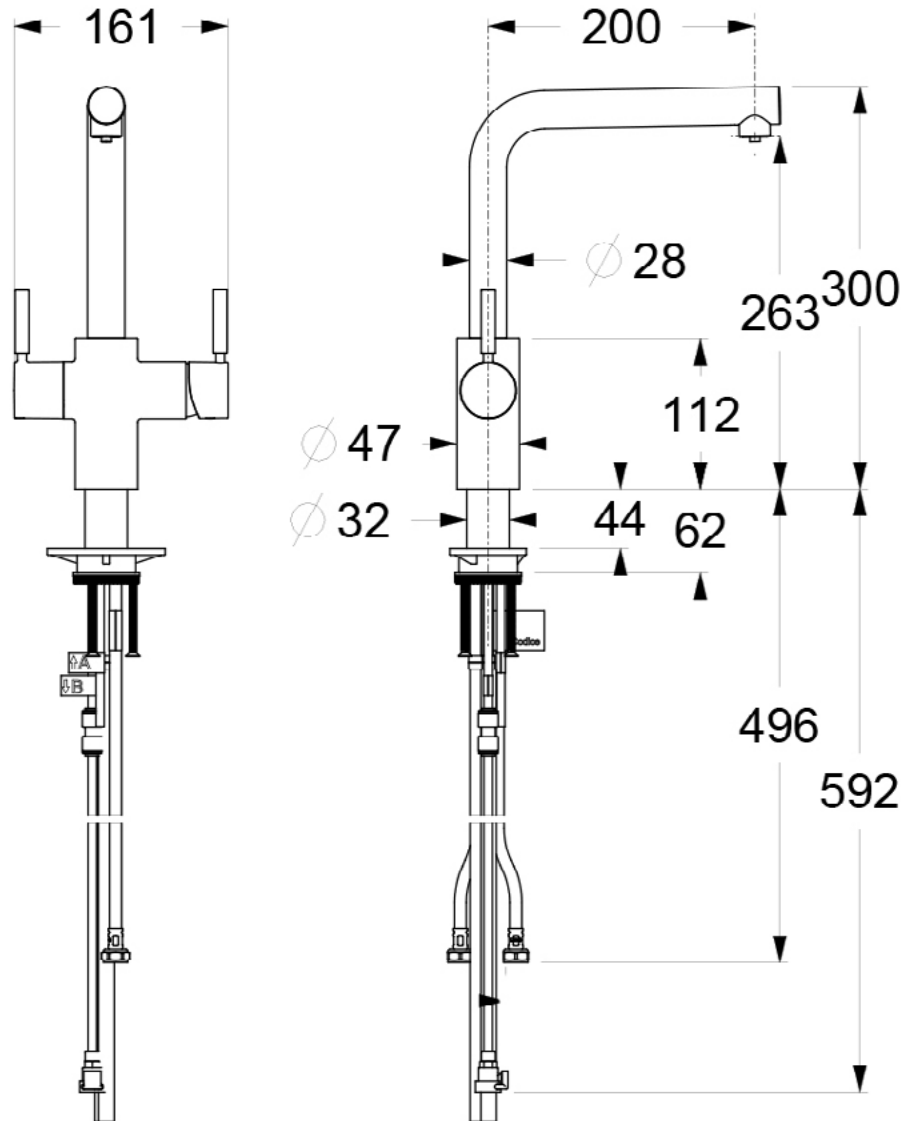

InSinkErator
Suite 10, Building 6
Hatters Lane
Croxley Green Business Park
Watford, Herts WD18 8YH
United Kingdom
Sales tel: 01923 297 880
Service tel: 0800 389 3715
www.insinkeratorsco.co.uk

InSinkErator
Emerson Electric Co.
4700 21st Street
Racine, WI 53406-5093 USA
Sales/Service tel: +1 262-554-5432
www.insinkerator.com/worldmap.html

Pending

WRAS
APPROVED
PRODUCT